

# LPR H.265+ Mini Bullet Network Camera



IP67

IK10

DATASHEET

## KEY FEATURES

- ▶ **Smart Stream** (Bandwidth, storage and bit rate are saved with Smart Stream On, eg, H.265+ saves 70%~80% bandwidth that of H.264.)
- ▶ **Powerful IR LEDs** (Equipped with 3rd generation dot matrix IR LEDs, guaranteeing excellent image quality, long lifespan and energy efficiency.)
- ▶ **Advanced Functions** (Boasting to support various advanced functions such as HLC, Defog, ROI.)
- ▶ **256G** (Supporting ultra-large external microSD/SDHC/SDXC card storage up to 256G.)
- ▶ **Adjustable 3-Axis Bracket** (Providing a robust mounting platform for angle adjustments on a 3-axis plane.)

### License Plate Recognition

Embedded in camera with no PC server required, the LPR allows network cameras to capture real-time license plate in both the highest levels of glare and the darkest hours of the night.



### 120fps

With the industry leading frame rate reaching 120fps, the cameras can easily catch images with no latency despite of the high-speed movement, which is the best choice for the demanding requirements especially for intelligent cameras.

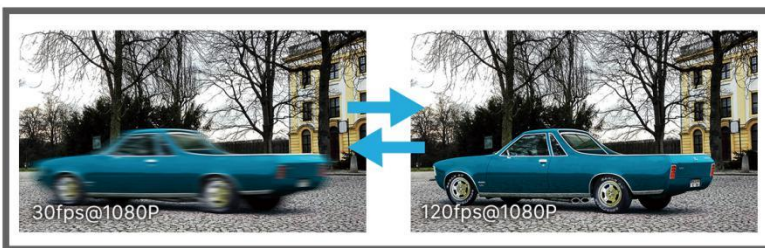

### 3 in 1 Super WDR Pro - 140dB

Milesight upgraded 3 in 1 Super WDR Pro outputs three frames each line, which is able to bring more details especially moving subjects. What's more, it greatly improves image quality for reducing smear and noisy points. The ratio that the brightest light signal values divided by the darkest light signal values is up to 140dB.

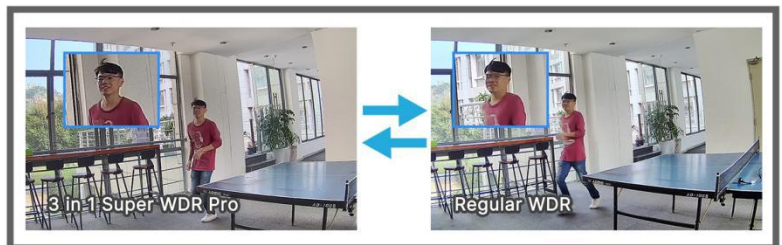

### 0.002Lux Ultra Low-light

The starlight camera is able to deliver high detailed color images even in low light environment reaching 0.002Lux(Color) or 0Lux(B/W), and near infrared light environments without any supplementary lighting.



# LPR H.265+ Mini Bullet Network Camera



	Model	MS-C2963-(Q)(R)LPB (2MP)
<b>Camera</b>	Image Sensor	1/2.8" Progressive Scan CMOS
	Min. Illumination	Color: 0.002Lux@F1.2 Color: 0.005Lux@F1.6/F2.0 B/W: 0Lux with IR on
	WDR	140dB Super WDR ( <b>Super WDR Pro is optional for Q Series</b> )
	Lens	4mm/2.8mm/6mm@F1.6; 2.8mm@F2.0
	Mount	M12
	Field of View	H91°/D106°/V50°(4mm) H111°/D128°/V61°(2.8mm) H55°/D63°/V32°(6mm)
	Shutter Time	1/100000s~1s
	IR Distance	Up to 50m
	Day/Night Mode	Day/Night/Auto/Customize/Schedule
	S/N	>55dB
<b>LPR</b>	Max. Vehicle Speed	200km/h
	Recognition Accuracy	>95%
	Coverage	Support simultaneous detection of 4 regions
	Vehicle Detection	Support vehicle direction detection
	White/Black List	Up to 1000 records inside the camera
<b>Video</b>	Max. Image Resolution	1920x1080
	Primary Stream	<b>120fps@(1920x1080)(Optional for Q Series)</b> , 60fps@(1920x1080, 1280x960, 1280x720, 704x576)
	Secondary Stream	60fps@(704x576, 640x480, 640x360, 352x288, 320x240, 320x192, 320x180)
	Tertiary Stream	30fps@(1920x1080, 1280x720, 704x576, 640x480, 640x360, 320x240, 320x192, 320x180)
	Video Compression	H.265+/H.265(HEVC)/H.264+/H.264/MJPEG
	Video Bit Rate	16Kbps~16Mbps(CBR/VBR Adjustable)
	Privacy Masking	Up to 24 areas
	ROI	Up to 8 areas
	Image Setting	Brightness/Contrast/Saturation/Sharpness
<b>Interface</b>	Ethernet	1*RJ45 10M/100M Ethernet Port
	Audio I/O	1/1 (Multi-interface Version)
	Alarm I/O	1/1 (Multi-interface Version)
<b>Network</b>	Network Storage	NAS(Support NFS, SMB/CIFS), ANR
	Protocol	IPv4/IPv6, ARP, TCP, UDP, RTCP, RTP, RTSP, RTMP, HTTP, HTTPS, DNS, DDNS, DHCP, FTP, NTP, SMTP, SNMP, UPnP, Bonjour, SIP, PPPoE, VLAN, 802.1x, QoS, IGMP, ICMP, SSL
<b>Audio</b>	Audio Compression	G.711/AAC/G.722/G.726
	Audio Sampling Rate	8/16/32/48KHz
	Audio Bit Rate	16~256kbps
	Two-way Audio	Support



<b>System</b>	Storage	Support microSD/SDHC/SDXC Card Local Storage, up to 256G
	Advanced Function	BLC, HLC, 2D DNR, 3D DNR, Defog, AWB, EIS, IP Address Filtering, AGC, Anti-flicker, Corridor Mode, Deblur, Watermark
	SIP/VoIP Support	Yes, Voice & Video-over-IP
	Event Trigger	Black/White List, Motion Detection, Network Disconnection, etc. Black/White List, Motion Detection, Network Disconnection, External Input, Audio Alarm, etc. (Multi-interface Version)
	Event Action	FTP Upload, SMTP Upload, SD Card Record, SIP Phone, HTTP Notification, etc. FTP Upload, SMTP Upload, SD Card Record, External Output, SIP Phone, HTTP Notification, etc. (Multi-interface Version)
	License Plate Recognition	Support
	System Compatibility	ONVIF Profile G & Q & S & T, API
<b>General</b>	Working Temperature	-40°C~60°C
	Working Humidity	0~90%(Non-condensing)
	Power Supply	PoE (802.3af); PoE (802.3af) / DC 12V±10% (Multi-interface Version)
	Power Consumption	4.2W MAX 5.7W MAX (With IR on)
	Weather Proof	Up to IP67-rated for Weather-resistant Performance
	Housing	Vandal-proof IK10-rated Metal Housing
	Weight	750g
	Dimensions	Φ76mmX214.5mm
	Warranty	3/5 Years

# LPR H.265+ Mini Bullet Network Camera



## Structure Diagrams

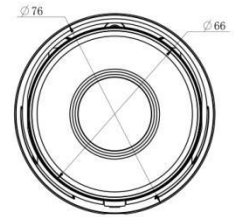
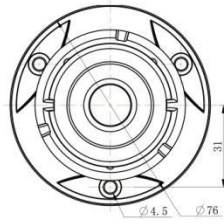
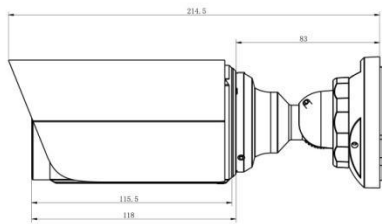
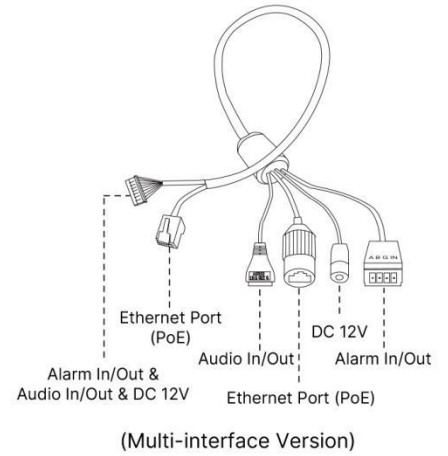
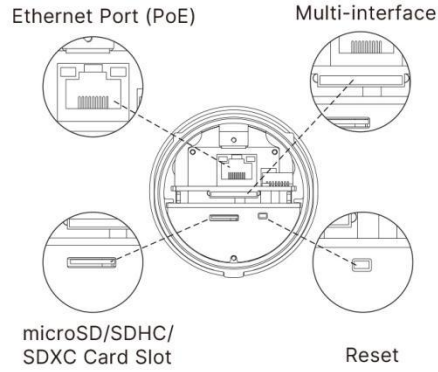
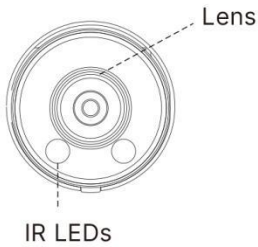

Units: mm

## Accessories Support

A01 Pole Mount

Weight: 720g  
Dimensions: 170\*51.5\*152.6mm



A03 External Corner Bracket

Weight: 900g  
Dimensions: 170\*152.5\*76.3mm



A63 Junction Box

Weight: 620g  
Dimensions: 134\*126\*40mm



Milesight Technology Co., Ltd. | [www.milesight.com](http://www.milesight.com)

Contact Us: [sales@milesight.com](mailto:sales@milesight.com) [support@milesight.com](mailto:support@milesight.com)

Add: 220 NE 51st Street, Oakland Park, Florida 33334, USA  
Tel: +1-800-561-0485

Add: 925, Anyang SK V1 Center, LS-ro 116beon-gil, Dongan-gu, Anyang-si, Korea  
Tel: +82-31-990-7732

Add: No.23 Wanghai Road, 2nd Software Park, Xiamen, China  
Tel: +86-592-5922772

